



800-899-2444 FAX 603-647-6770

DATE _____
 CUSTOMER _____
 ORDERED BY _____
 PHONE _____ FAX _____
 P.O. NUMBER _____
 JOB NAME _____
 REQUEST DATE _____

19 _____
 22 1/4" _____
 25 1/4" _____

FINISHED END

STYLE _____
 COLOR # _____

FINISHED END

Assemble Assemble
 Loose Loose

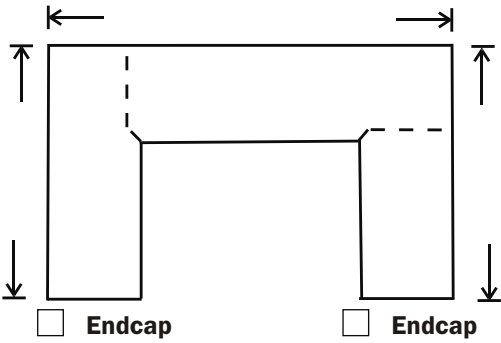

Assemble Assemble
 Loose Loose

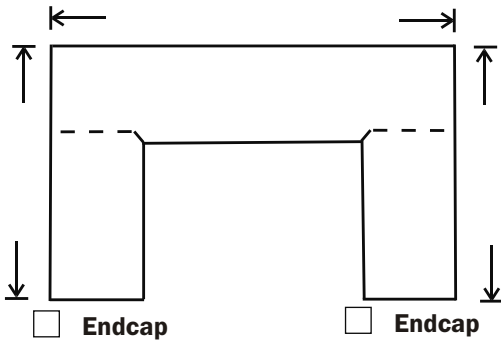

IMPORTANT

1. ADDITIONAL EASED EDGES, CLIPPED CORNERS & ANGLE END BASES MAY BE DRAWN IN WHERE NEEDED.
2. INCLUDE SPECS FOR ALL ANGLE END BASES.

Sink cut out: (Standard Stainless Steel)

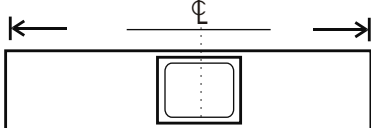

25" X 22" Single Bowl
 33" X 22" Double Bowl

OFFICE USE
 PICK TICKET # _____
 SHIP DATE _____

**OFFSET
 MITRE
 FORM**

STYLE _____
 COLOR # _____
 COLOR NAME _____

ISLAND

C.C. or
 E.E. _____

Bullnose _____
 Finished End _____

C.C. or
 E.E. _____

C.C. = Clipped Corner
 E. E. = Eased Edge

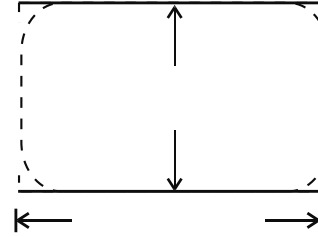

C.C. or
 E.E. _____

Bullnose _____
 Finished End _____

C.C. or
 E.E. _____

Assemble
 Loose

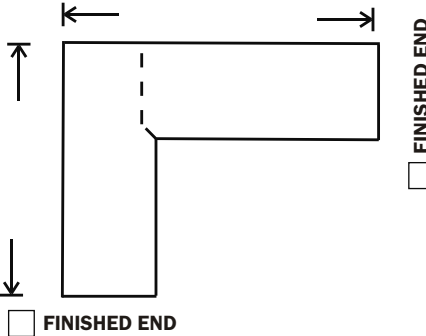

Assemble
 Loose

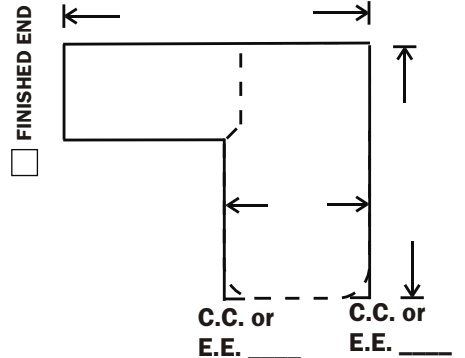
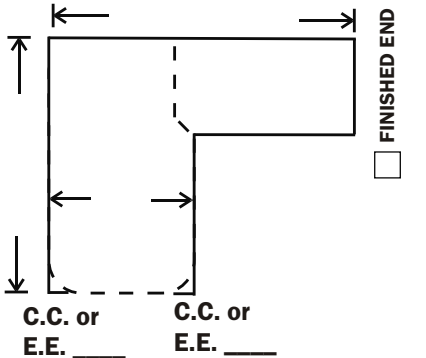
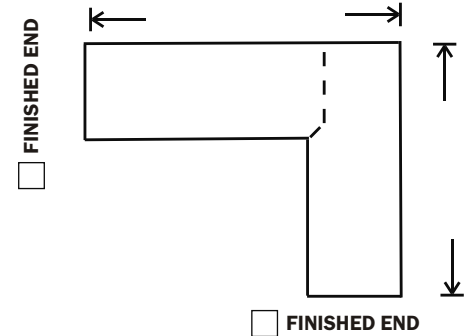

Assemble
 Loose

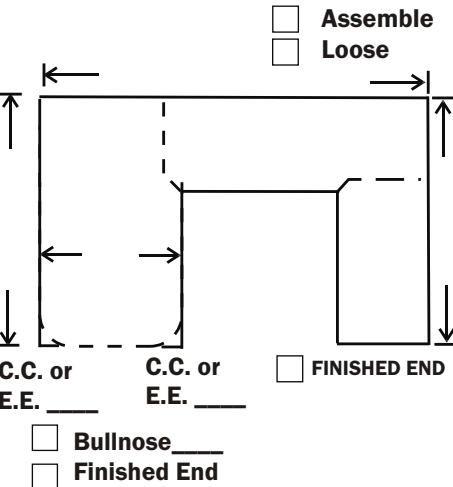

Assemble
 Loose

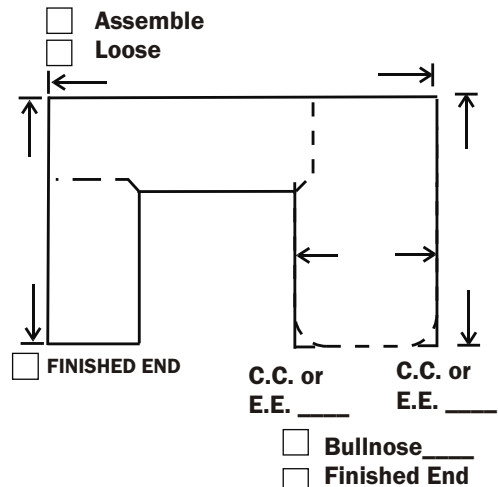

NOTES / SPECIAL INSTRUCTIONS

