

POSTFORM FABRICATION CHARGES: MITRES & BUTTT JOINTS

NOTES AND INFORMATION

MITRES

PRICING GUIDE

Standard Mitre

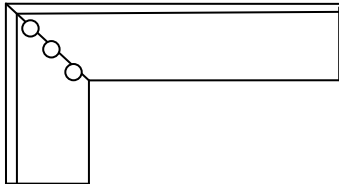

Maximum return is 60"
 Assembled returns 61" to 72"
 (Returns greater than 61" need approval due to shipping concerns)

Loose

Assembled

\$28.00
 \$28.00

\$54.00
 \$60.00

Peninsula (Bar Top) Mitres

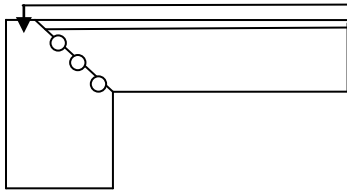

For 36" bar tops, please specify if back of bar is to be finished, and if so, add bar cap (end cap) charge:
 Loose = \$6.00 / Applied = \$14.00

Maximum 48" bar length

\$28.00

\$60.00

Reverse Mitres

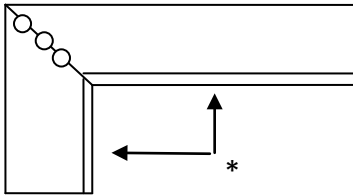

Provide wall dimensions
 * = backplash

\$38.00

\$64.00

Out of Square Mitres

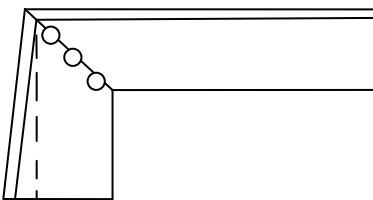

Provide "3'-4'-5" dimensions

\$64.00

\$72.00

22 1/2" Mitres

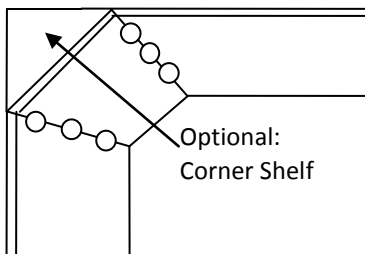

Optional:
 Corner Shelf

Provide front & back dimensions.
 Template may be necessary if dimensions are difficult to work with.

\$45.00

\$66.00

Corner shelf option: \$38.00

POSTFORM FABRICATION CHARGES: MITRES & BUTTT JOINTS

NOTES AND INFORMATION

MITRES

Offset Mitres (for Flat Deck or Custom Tops)

Example 1: L-Shaped

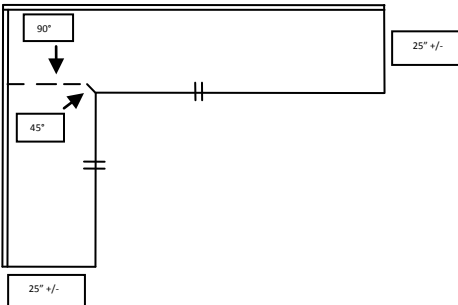

Designed for use with Postform Flat Deck (as well as Custom Square, Wood Edge, and Bevel Edge tops)

Provide back wall dimension and specify "Offset Mitre"

Example 2: U-Shaped

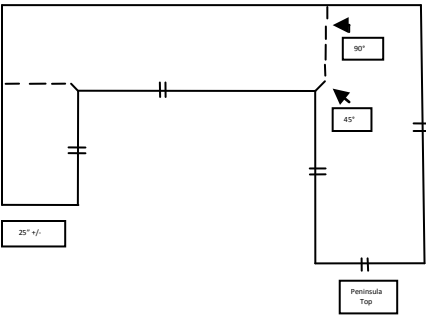

Please see "Offset Mitre Pricing and Information" page for the specifics and benefits of offset mitres

PRICING GUIDE

<u>Loose</u>	<u>Assembled</u>
\$60.00	\$80.00

NOTES AND INFORMATION

BUTT JOINTS

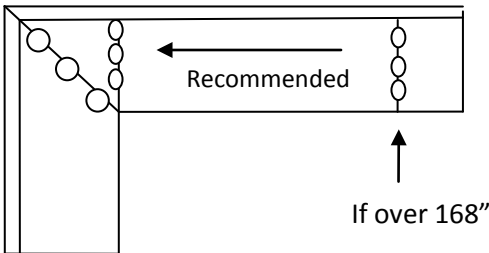

For tops over 144"

Seams are recommended away from sink cut outs

PRICING GUIDE

<u>Loose</u>	<u>Assembled</u>
\$28.00	\$58.00

ORDERING AND INSTALLING GUIDELINES

Mitres and butt joints should be away from sink area. Water and/or moisture damage is not covered under warranty.

Always use water resistant wood glue, in addition to bolts, when assembling mitres and butt joints.

Postform counter tops have their limitations—postform might not be suitable for all kitchen layouts.

POSTFORM MITRES & BUTT JOINTS INFORMATION

STANDARD MITRE

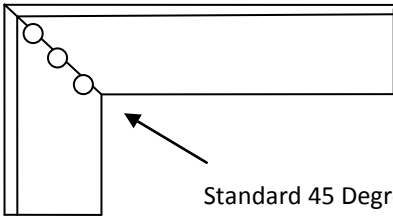

- (1) Loose or Assembled
- (2) Maximum Assembly is 60" Return

Standard 45 Degree Mitre

BUTT JOINT

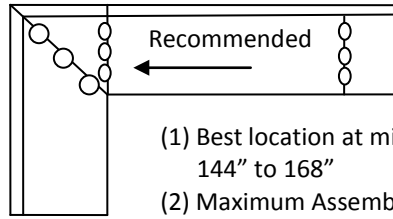

← Recommended ←
If over 168"

- (1) Best location at mitre, when top measures 144" to 168"
- (2) Maximum Assembly is 60" x 168"

PENINSULA MITRE

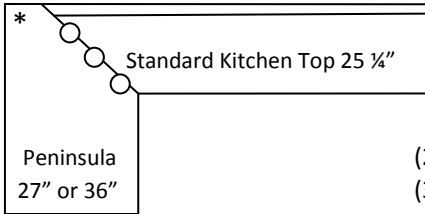

- (1) *= No Backsplash
27" Peninsula = 1 3/4"
36" Peninsula = 10 3/4"
(with 25 1/4" Kitchen)
- (2) Maximum Assembly is 48"
- (3) 45 Degree Mitres Only

Peninsula
27" or 36"

OUT OF SQUARE MITRE

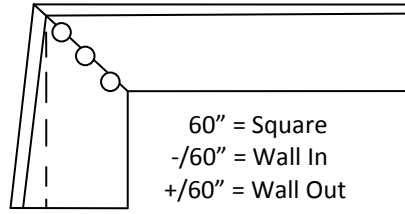

- (1) Provide * 3'-4'-5' Wall Measurement

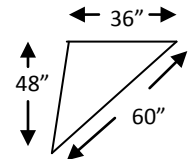

60" = Square
-/60" = Wall In
+/60" = Wall Out

REVERSE MITRE

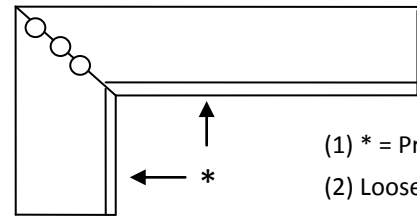

- (1) * = Provide these Measurements
- (2) Loose or Assembled

22 1/2 DEGREE MITRE

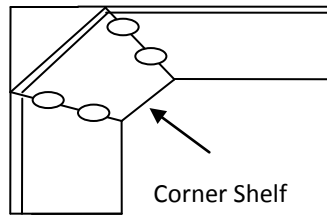

- (1) Never place sink in or near corner
- (2) Corner shelf butts back of backsplash, sold separately
- (3) Always Supply Template

Corner Shelf

OFFSET MITRES (FOR FLAT DECK POSTFORM OR CUSTOM TOPS)

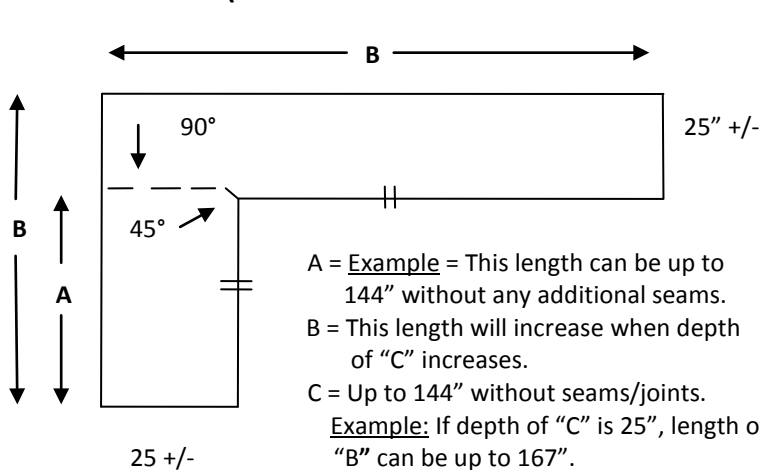

A = Example = This length can be up to 144" without any additional seams.
B = This length will increase when depth of "C" increases.
C = Up to 144" without seams/joints.
Example: If depth of "C" is 25", length of "B" can be up to 167".

Note:

- * Always provide back wall counter top measurements and specify "Offset Mitre"
- * Cannot be used with integral backsplash counter tops or bar top to bar top

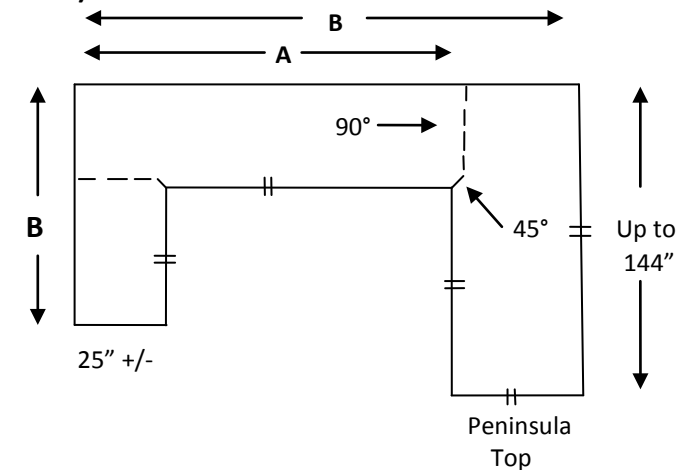

GUIDELINES

- Always keep mitres and butt joints away from sink areas. (Water/Moisture Damage is NOT covered under warranty).
- Always use water resistant wood glue in addition to bolts when assembling mitres and butt joints.
- Remember that postform tops have their limitations and may not be suitable for all kitchen layouts.



POSTFORM FABRICATION CHARGES
QUICK REFERENCE PRICING GUIDE

MITRES & BUTT JOINTS

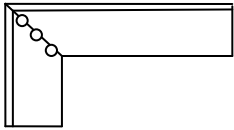

Standard Mitres:
Loose \$28.00 ea
Up to 60" Assem \$54.00 ea
61" to 72" Assem \$60.00 ea

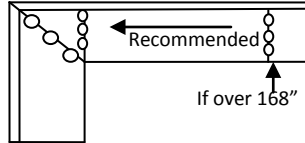

Butt Joints:
Loose \$28.00 ea
Assem \$58.00 ea
(For Tops over 144")

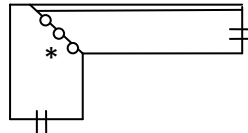

Peninsula Mitres:
Loose \$28.00 ea
Assem \$60.00 ea
(Max. 48" bar length)

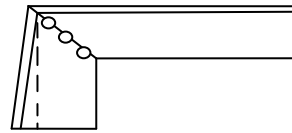

Out of Square Mitres:
Loose \$64.00 ea
Assem \$72.00 ea
(Provide 3'-4'-5' dim.)

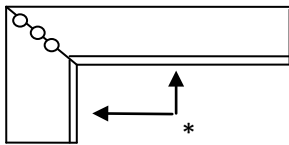

Reverse Mitres:
Loose \$38.00 ea
Assem \$64.00 ea
*(Provide wall dim.)

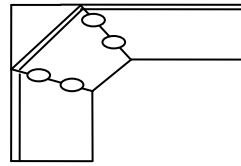

22 1/2 Mitres:
Loose \$45.00 ea
Assem \$66.00 ea
Corner Shelf \$38.00 ea
(Provide Template)

End Options & Special Cuts

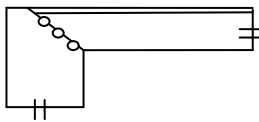

End Caps:
Loose \$ 6.00 ea
Applied \$14.00 ea

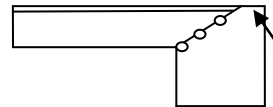

Backsplash Caps:
Loose \$ 6.00 ea
Applied \$14.00 ea



Eased Edges:
1 1/2" to 6" \$24.00 ea
(Add proper overhang)

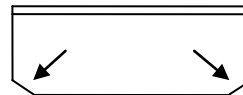

Clipped Corners:
2" to 6" \$24.00 ea
(Add proper overhang)

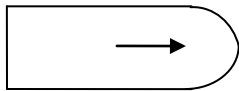

Bullnose Ends:
4" to 6" \$33.00 ea
(Add proper overhang)

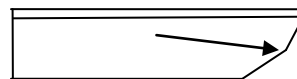

Angle End Base:
\$ 60.00 ea
(Provide spec's)



Angle Cut:
Unfinished \$30.00 ea
Finished \$38.00 ea

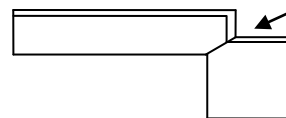

Pipe Chase Cut Out:
Cut Out \$54.00 ea
With Square Edge B/S
Loose \$80.00 ea

Endsplash Options

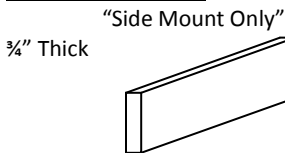

Standard End Splash:
Loose \$16.00 ea
Applied \$24.00 ea
Radius - ADD \$20.00 ea
Add Scribe to End Splash \$3.50 ea

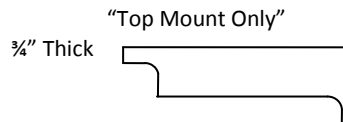

Profile End Splash:
Loose Only \$32.00 ea
Radius - ADD \$20.00 ea

Other Charges

- + Cut off Backsplash or cut down Island Top \$ 4.00 LF
- + Cut off Backsplash and Reapply (for custom depth) \$10.00 LF
- + Cut down and finish square (for custom depth) \$11.00 LF
- + Double Thick Tops (Double Build Up) extra build up \$ 5.00 SF
- + Double Thick Tops with Backer 12" pad for Bar 36" \$ 9.00 LF
- + Sink Cut Outs (Standard, Stainless Single or Double) \$15.00 ea

- + Sink Cut Outs (Non-Standard) \$30.00 ea
- + Cook Top Cut Outs \$30.00 ea
- + Stove Cut Outs (Finished) \$90.00 ea
- + Apron or Skirt Applied (up to 6") \$14.50 LF
- + Full Cardboard Wrap \$ 2.00 LF
- + Matching Seamfil (Stock Colors) \$18.00 ea



OFFSET MITRE JOINTS PRICING AND INFORMATION
FOR POSTFORM FLAT DECK, CUSTOM SQUARE EDGE, WOOD EDGE AND BEVEL EDGE TOPS

Loose: \$60.00

Assembled: \$80.00

The offset mitre joint specifically designed for use with Postform "Flat Deck", Custom Square Edge, Wood Edge and Bevel Edge tops has the following benefits:

- Easy to assemble
- Shorter seam length
- Allows for longer lengths without additional joints
- Can be left or right
- Can be loose or assembled

SPECIAL NOTES:

- When ordering, always provide the back wall dimension and specify "Offset Mitre".
- **IMPORTANT: CANNOT BE USED WITH INTEGRAL BACKSPLASH COUNTER TOPS!**
- Cannot be used for finished bar top to bar top

Example 1: Flat Deck L-Shaped Kitchen

E-2000 Flat Deck with optional loose custom backsplash

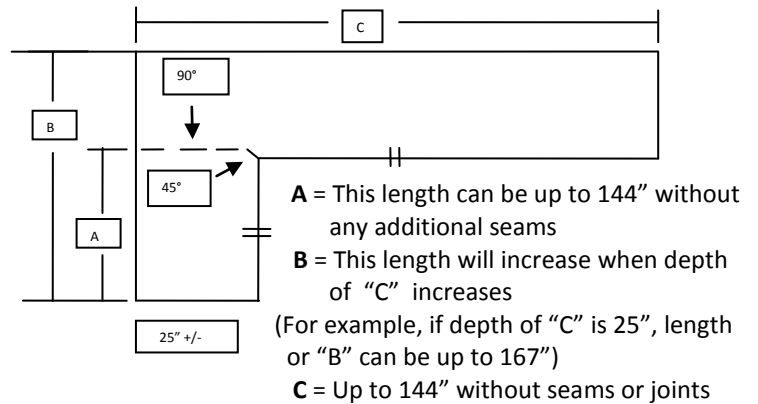
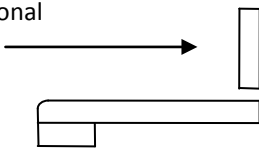

Example 2: L-Shaped and U-Shaped Flat Deck Kitchen with Peninsula Top

